

FS-ARCCB Insert compatible with Architects of the West Kingdom®: Collector's Box, including Age of Artisans®, Works of Wonder®, and promo player boards



Assembly Instructions

The package contains 5 sheets: two double and one single sheet.
After assembly the trays are put in up to two layers in the original game box.
Ordinary PVA glue is required when assembling each tray.
Please make sure you dry-assemble each tray correctly before gluing it together.
Please check www.foldedspace.com for general assembly tips.

FS-ARCCB

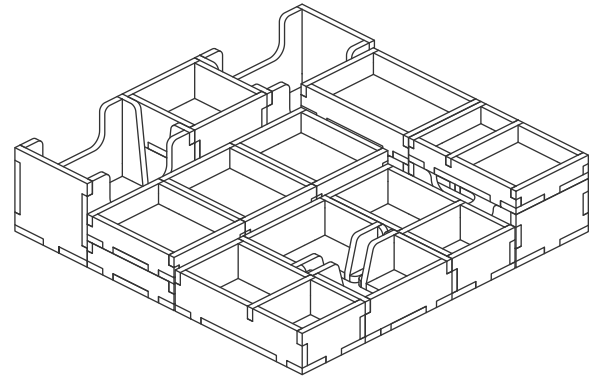

Sheet 1 & 4 Sheet 2 & 5 Sheet 3

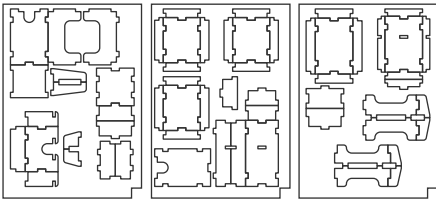

Tray 1a, 1b

Sheet 1 & 4

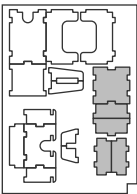

(the trays are identical)

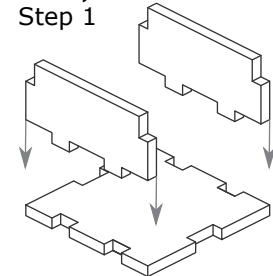

Step 2

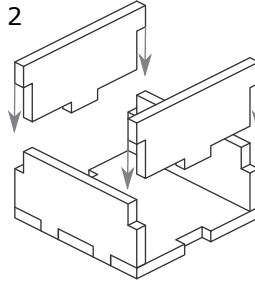

Finished tray

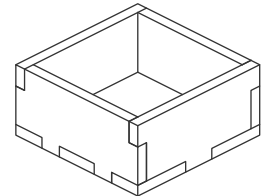

Tray 2

Sheet 3

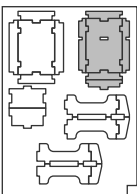

Step 1

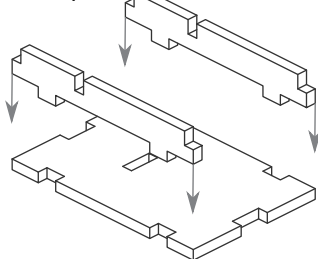

Step 2

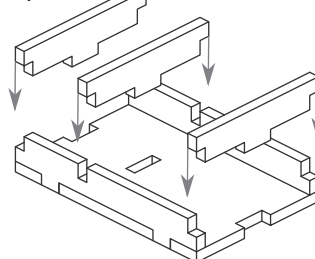

Finished tray

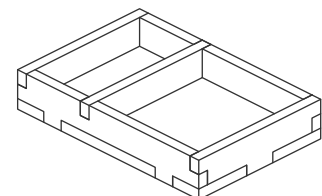

Tray 3a, 3b

Sheet 1 & 4

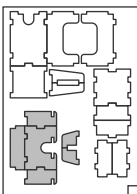

(the trays are identical)

Step 1

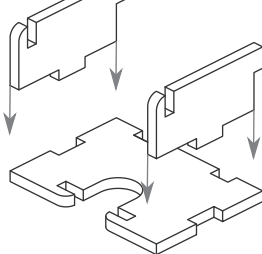

Step 2

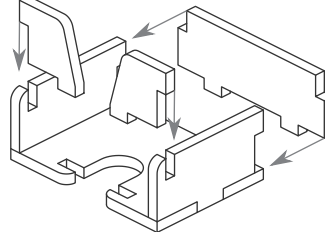

Finished tray

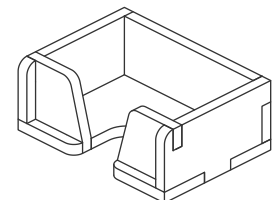

Tray 4a, 4b

Sheet 2 & 5

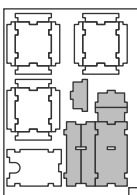

(the trays are identical)

Step 1

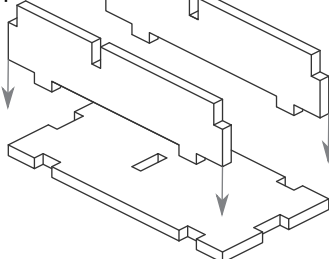

Step 2

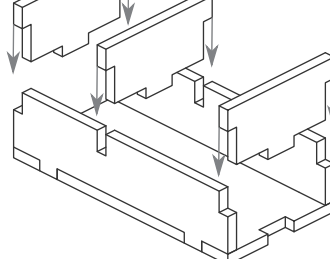

Finished tray

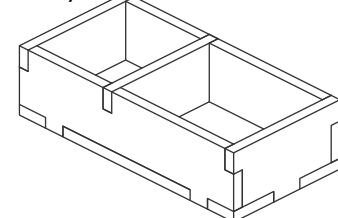

FS-ARCCB Insert compatible with

Architects of the West Kingdom®: Collector's Box, including Age of Artisans®, Works of Wonder®, and promo player boards



Tray 5a, 5b (the trays are identical)

Sheet 1 & 4

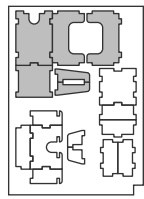

Step 1

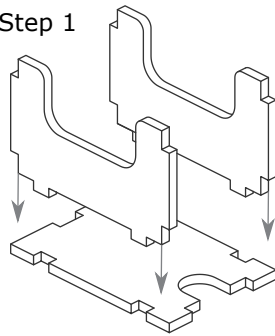

Step 2

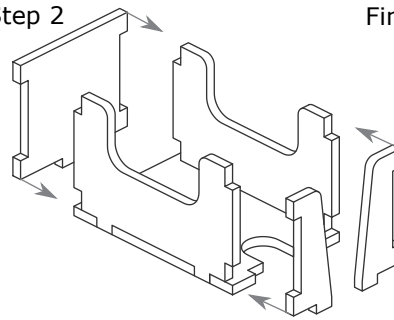

Finished tray

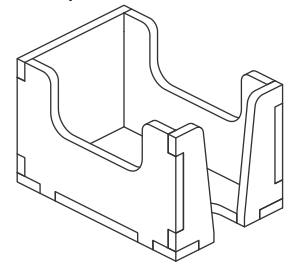

Tray 6a-6f, 7

Sheet 2 & 5

Sheet 3

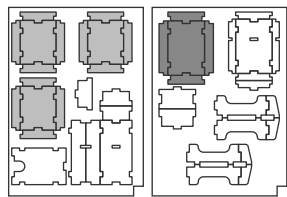

(trays 6a-6f are identical)

Step 1

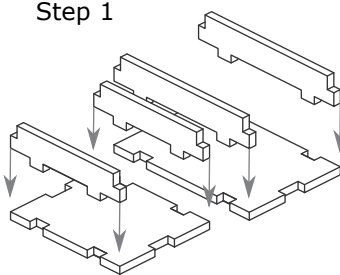

Step 2

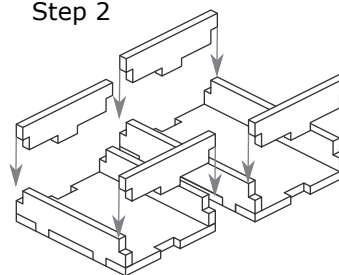

Finished trays

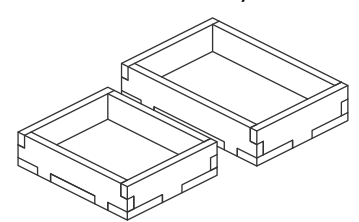

Tray 8a, 8b

(Tray 8a pieces marked with ★, and Tray 8b pieces marked with ●)

Sheet 2 & 5

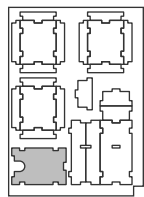

Step 1

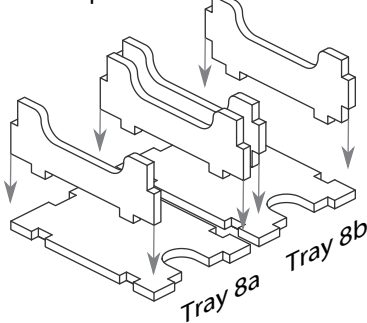

Step 2

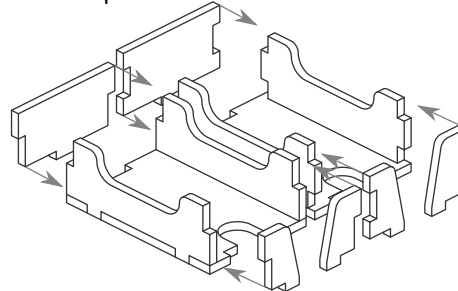

Finished trays

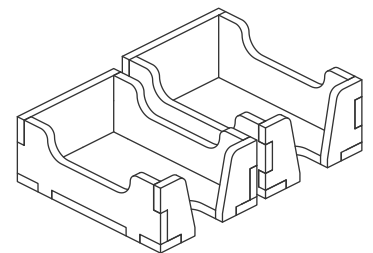

Sheet 3

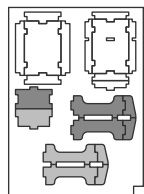

FS-ARCCB

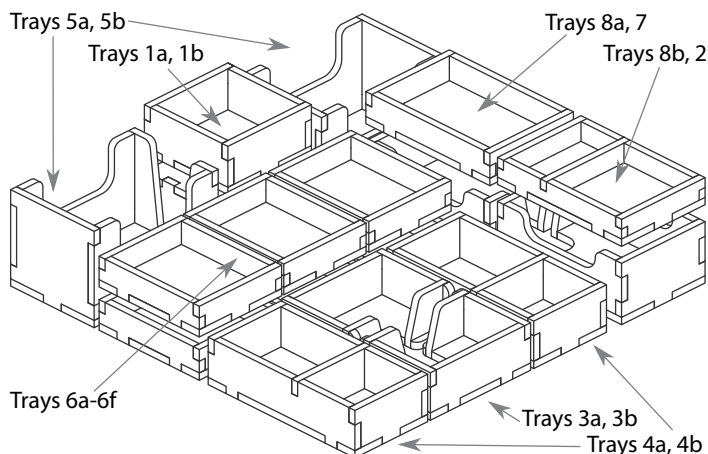

Please check www.foldedspace.com for photos of this insert in use.

Tray legend:

- Tray 1a, b - silver coins
- Tray 2 - wood and princess, profiteer, & resource markers
- Tray 3a - reward & black market cards
- Tray 3b - debt & multiplier cards
- Tray 4a, b - clay & gold, and stone & marble
- Tray 5a - apprentice cards
- Tray 5b - building cards
- Tray 6a, b, c, d, e, f - player pieces
- Tray 7 - wonder tokens
- Tray 8a - craft, black market overlay, wonder & contribution/consequence cards
- Tray 8b - solo scheme card decks

Note: the player boards are placed in the recess on top of Trays 3 and 4.