

# FS-SGRDA insert compatible with Sagrada®, incl. 5-6 Player Expansion®, Passion®, Life® and various promos



## Assembly Instructions

The package contains 3 sheets, two identical and one different sheet.

After assembly the trays are put in three layers in the original game box.

Ordinary PVA glue is required when assembling each tray.

Please make sure you dry-assemble each tray correctly before gluing it together.

Please check [www.foldedspace.net](http://www.foldedspace.net) for general assembly tips.

## FS-SGRDA

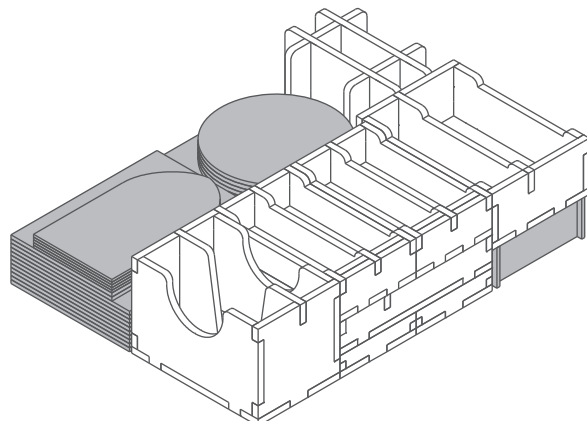

Sheet A1

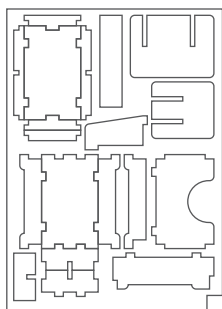

Sheet A2

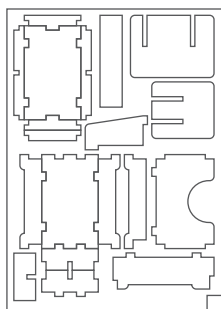

Sheet B1

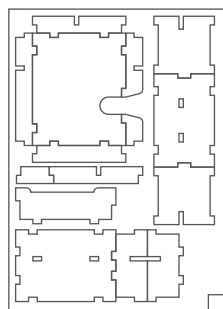

### Tray 1a & 1b (the trays are identical)

Sheet A1

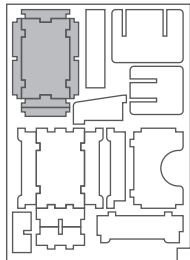

Sheet A2

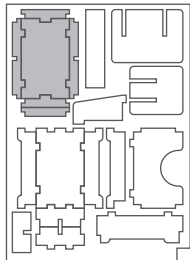

#### Step 1

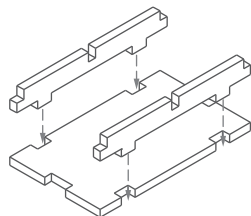

#### Step 2

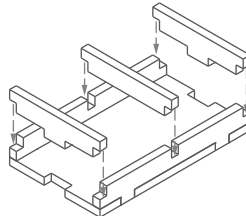

#### Finished tray

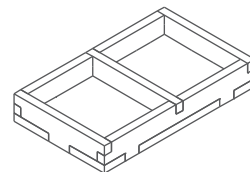

### Tray 2a & 2b (the trays are identical)

Sheet A1

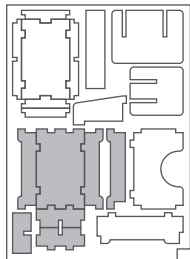

Sheet A2

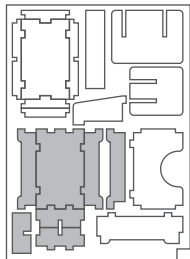

#### Step 1

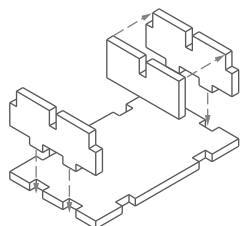

#### Step 2

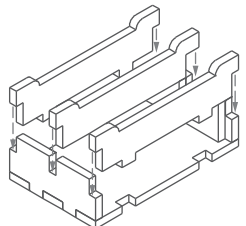

#### Finished tray

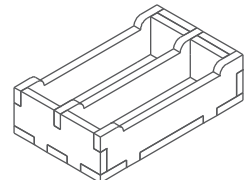

### Tray 3

Sheet A1

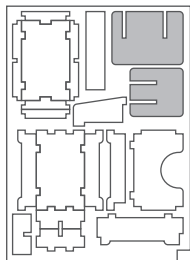

Sheet A2

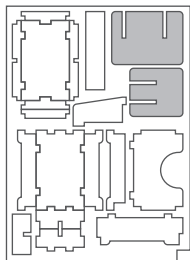

#### Step 1

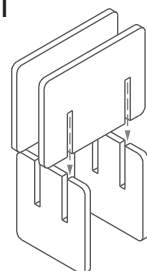

#### Finished tray

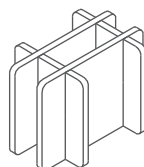

### Tray 4

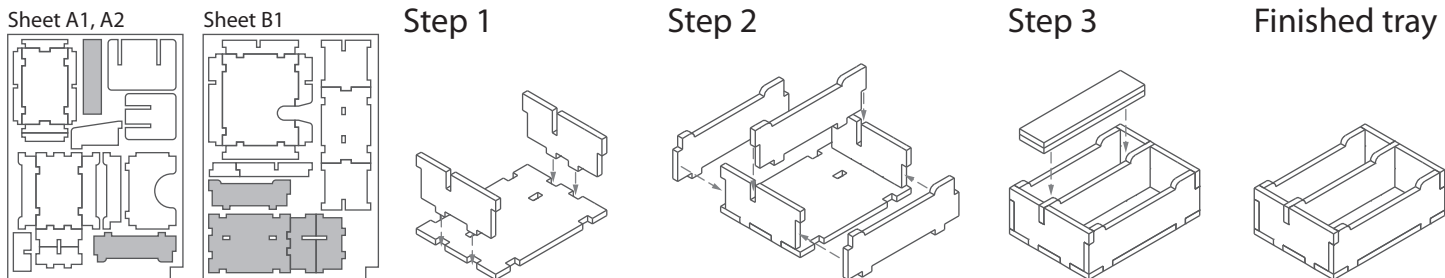

### Tray 5

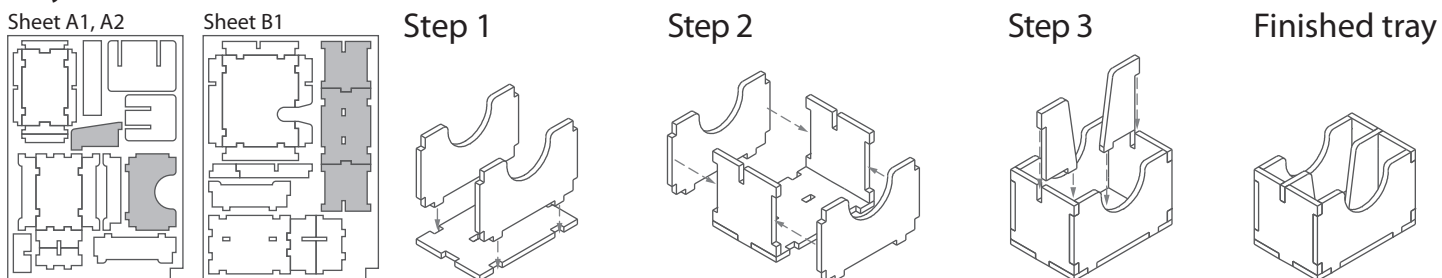

### Tray 6

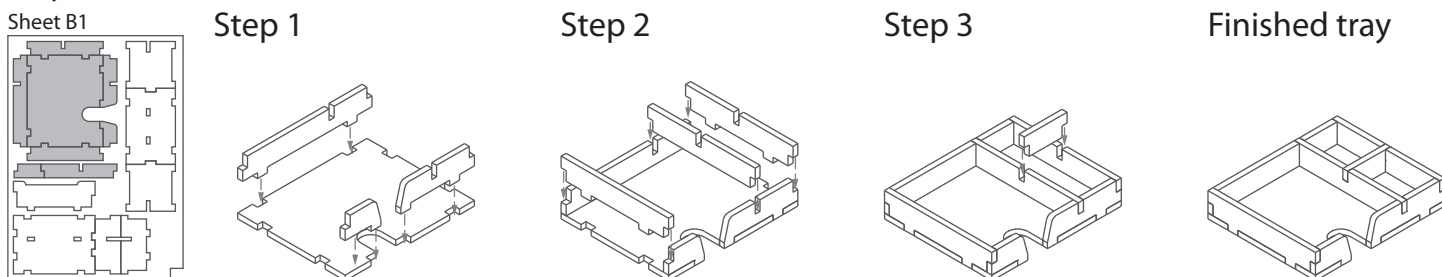

## FS-SGRDA

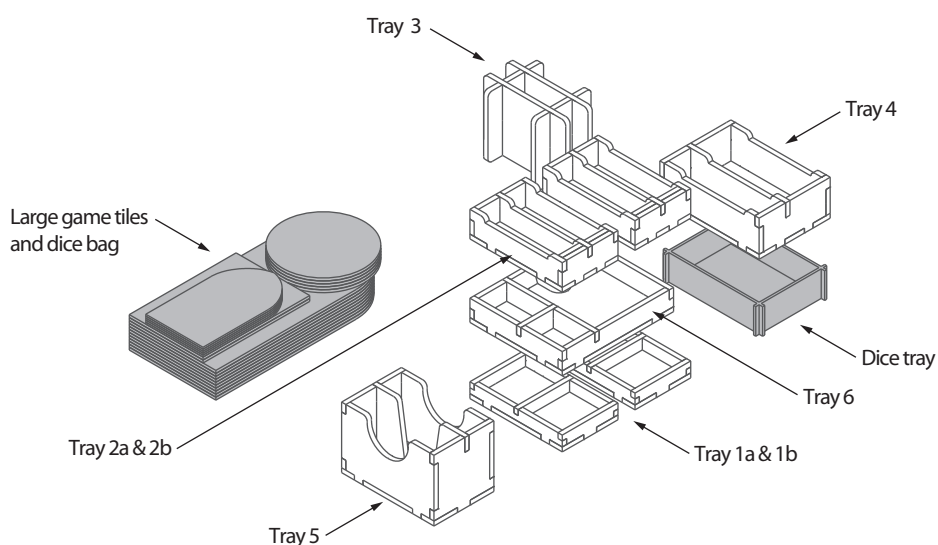

Please check [www.foldedspace.net](http://www.foldedspace.net) for photos of this insert in use.

### Tray legend:

- Tray 1a - orange and rare glass dice
- Tray 1b - reserve tray
- Tray 2a - purple and yellow dice
- Tray 2b - red and green dice
- Tray 3 - filler tray. Note that the walls are slightly longer on one side, this side should point into the box towards the other insert trays
- Tray 4 - favor tokens and blue dice
- Tray 5 - game cards
- Tray 6 - window pattern cards and score markers

Note: the large game tiles are stacked on the left hand side of the box together with the folded dice bag. These include the expansion rule books, window frame player boards, the rare glass boards, the private dice pool boards, the masterwork board, and the round track board.

If you are fortunate enough to also own the original dice tray from the first Kickstarter campaign, this too can be placed here with the boards.