

FS-FCM insert

compatible with Food Chain Magnate[®],

and separately with The Ketchup Mechanism & Other Ideas[®] expansion



Assembly Instructions

FS-FCM

The package contains 4 sheets, two identical to the other two and one different sheet.

The parts marked in sheet A2 are to be discarded.

After assembly the trays are put in two layers in the original game box.

Ordinary PVA glue is required when assembling each tray.

Please make sure you dry-assemble each tray correctly before gluing it together.

Please check www.foldedspace.net for general assembly tips.

Note that three trays have alternative assembly methods when used for the game or for the expansion.

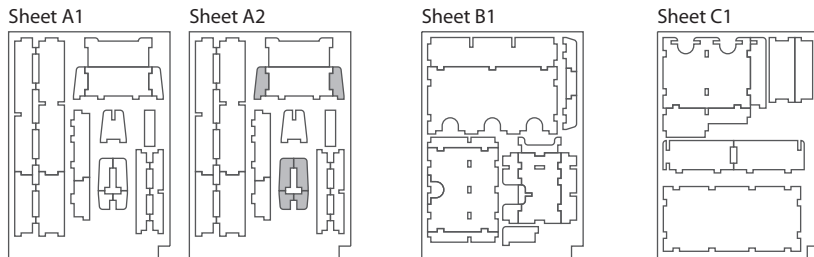
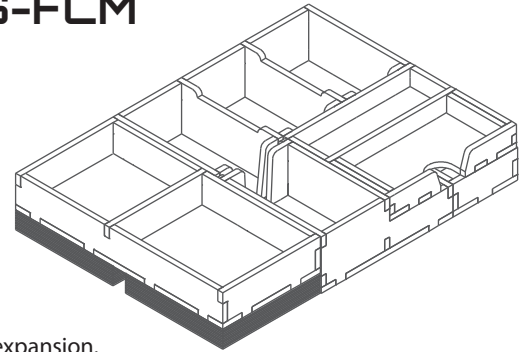

Tray 1_{v1} (the tray is used in Food Chain Magnate version)

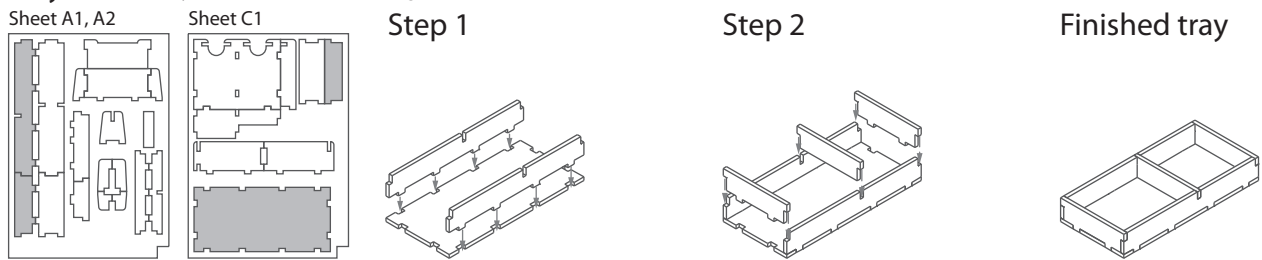

Tray 1_{v2} (the tray is used in The Ketchup Mechanism & Other Ideas version)

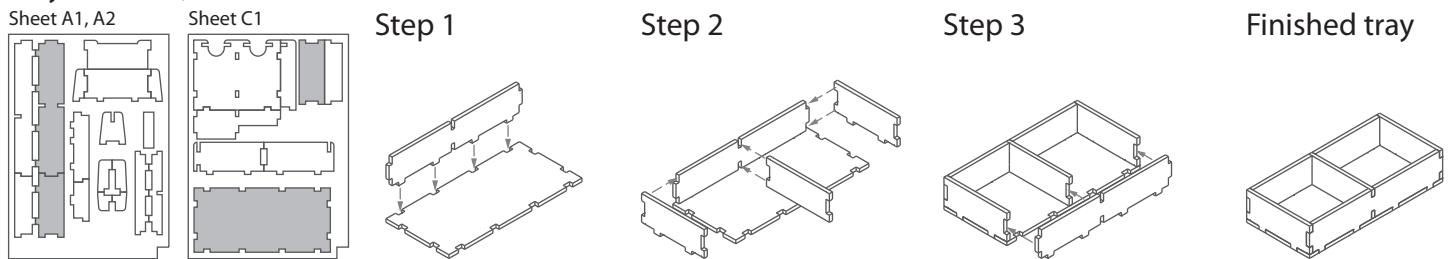

Tray 2_{v1} (the tray is used in Food Chain Magnate version)

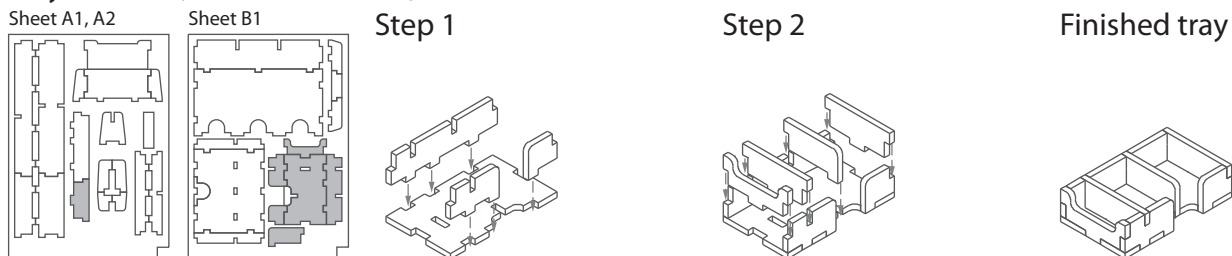

Tray 2_{v2} (the tray is used in The Ketchup Mechanism & Other Ideas version)

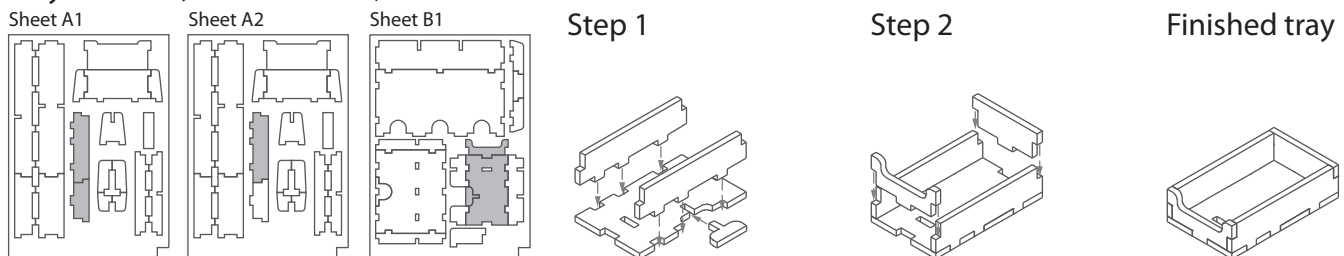

FS-FCM insert compatible with Food Chain Magnate®,
and separately with The Ketchup Mechanism & Other Ideas® expansion



Tray 3v1 (the tray is used in Food Chain Magnate version)

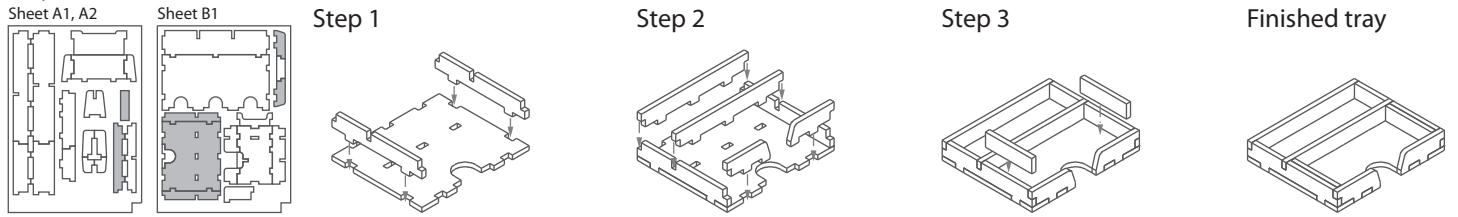

Tray 3v2 (the tray is used in The Ketchup Mechanism & Other Ideas version)

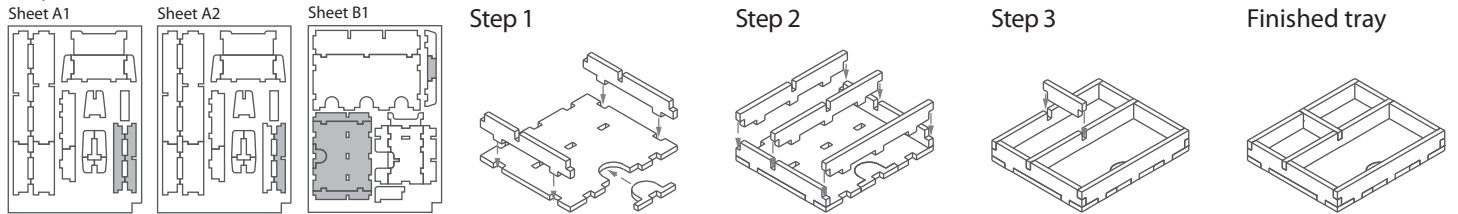

Tray 4

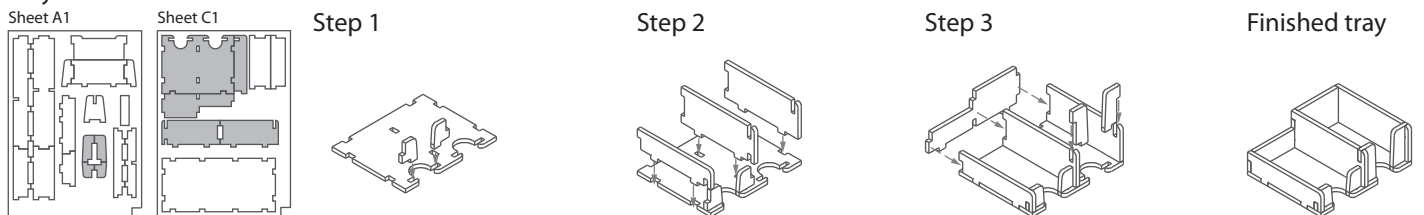

Tray 5

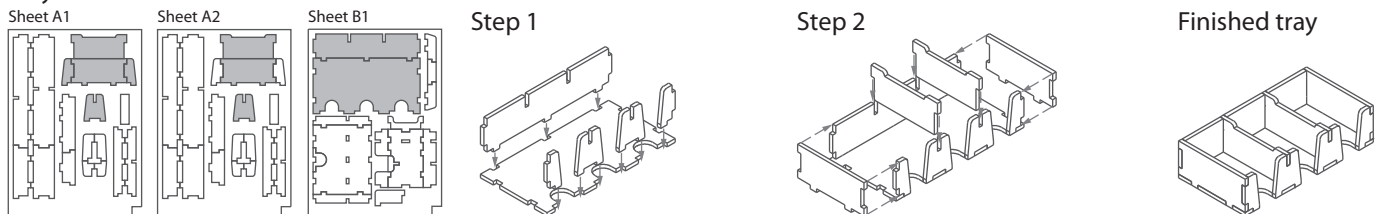

FS-FCM

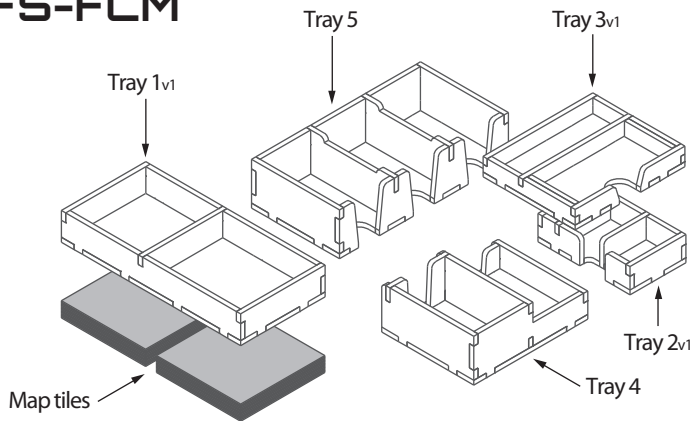

FOOD CHAIN MAGNATE

Tray legend:

- Tray 1v1 - food and drink wooden pieces
- Tray 2v1 - busy chips, marketing tiles, and house & garden tiles
- Tray 3v1 - restaurant & turn order markers, and paper money
- Tray 4 - milestone and other cards
- Tray 5 - employee cards

Please check www.foldedspace.net for photos of this insert in use.

Tip: Keep the instructions in the bottom of your board game box as a reminder of how the insert fits together.

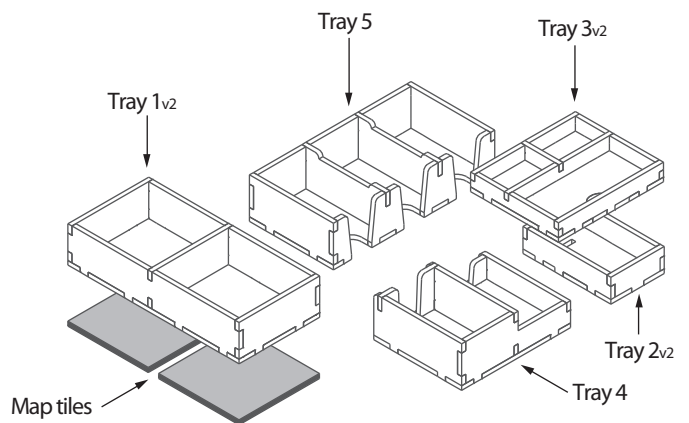

THE KETCHUP MECHANISM & OTHER IDEAS

Tray legend:

- Tray 1v2 - food and drink wooden pieces
 - Tray 2v2 - bigger coke & beer pieces
 - Tray 3v2 - coffee shops, roadblocks, parks, road, and giant billboard tiles
 - Tray 4 - milestone and reserve cards
 - Tray 5 - milestone and employee cards
- Note: the other marketing tiles and sixth player pieces go in the main game box trays.