

FS-SKYE insert
 compatible with Isle of Skye®,
 incl. Journeyman® and Druids® expansions.

Assembly Instructions

The package contains 2 sheets, both of them are identical.

The parts marked in sheet A2 are to be discarded.

After assembly the trays are put in two layers in the original game box.

Ordinary PVA glue is required when assembling each tray.

Please make sure you dry-assemble each tray correctly before gluing it together.

Please check www.foldedspace.net for general assembly tips.

FS-SKYE

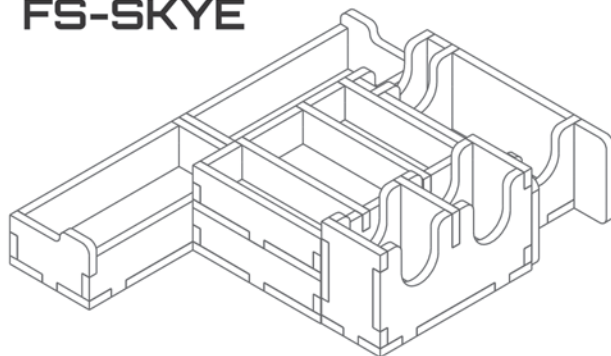

Sheet A1

Sheet A2

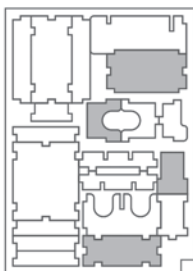
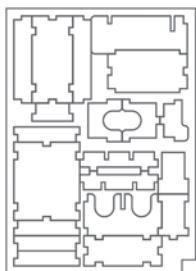

Tray 1a & 1b (the trays are identical)

Sheet A1

Sheet A2

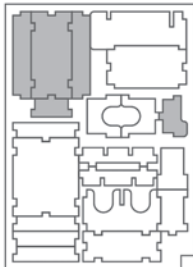
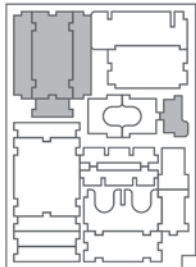

Step 1

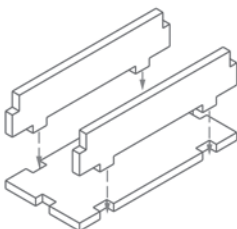

Step 2

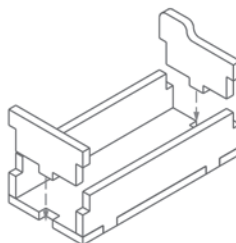

Finished tray

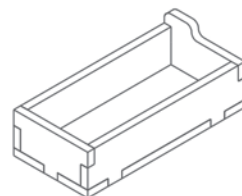

Tray 2a

Sheet A1

Sheet A2

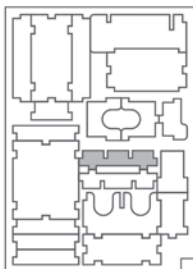
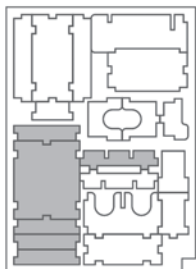

Step 1

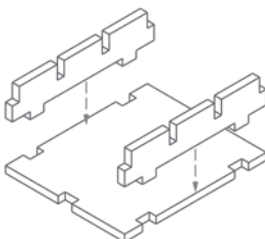

Step 2

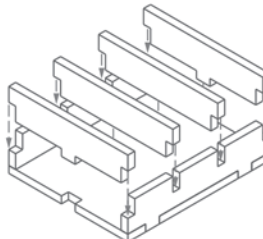

Finished tray

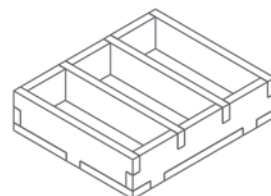

Tray 2b

Sheet A1

Sheet A2

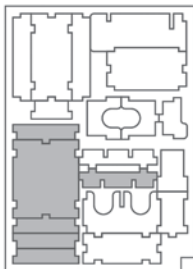
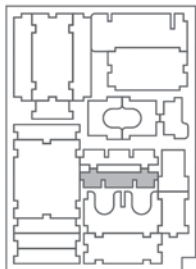

Step 1

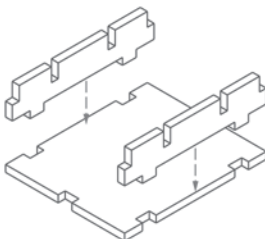

Step 2

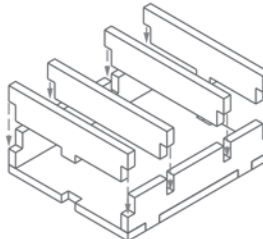

Finished tray

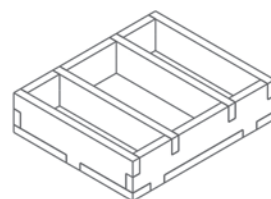

Tray 3

Sheet A1

Sheet A2

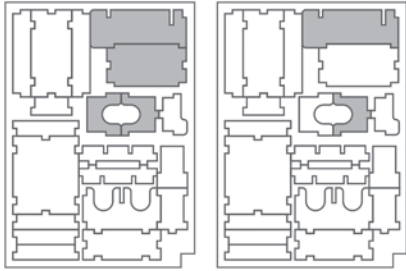

Step 1

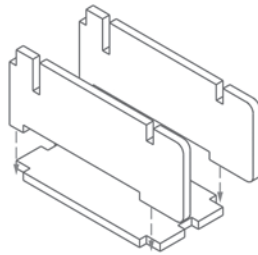

Step 2

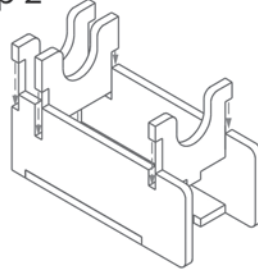

Finished tray

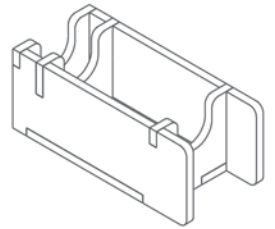

Tray 4

Sheet A1

Sheet A2

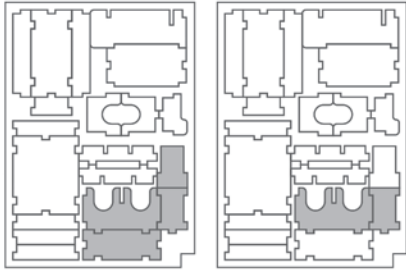

Step 1

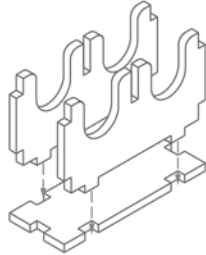

Step 2

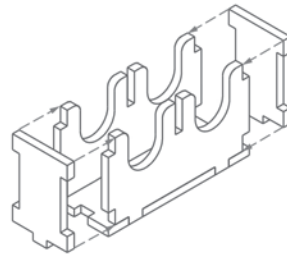

Step 3

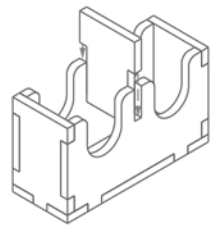

Finished tray

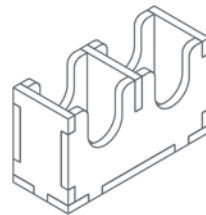

FS-SKYE

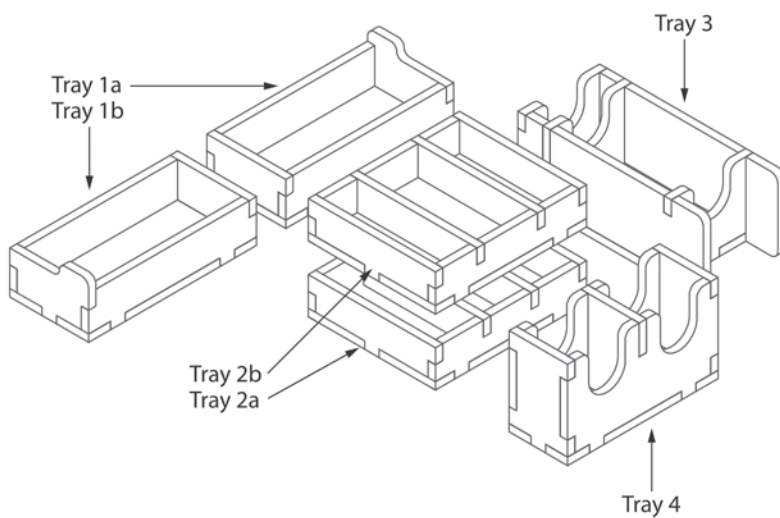

Please check www.foldedspace.net
for photos of this insert in use.

Tray legend:

- Tray 1a, b - coins
- Tray 2a - player pieces
- Tray 2b - player pieces, roads & other tiles
- Tray 3 - castle landscapes, druid tiles,
stone tablets
- Tray 4 - scoring tiles