

FS-ORLv2 insert
compatible with Orleans[®],
both the DLP and TMG versions.

Assembly Instructions

The package contains 3 sheets, two identical sheets plus one different sheet.

After assembly the trays are put in two layers in the original game box.

Ordinary PVA glue is required when assembling each tray.

Please make sure you dry-assemble each tray correctly before gluing it together.

Please check www.foldedspace.net for general assembly tips.

FS-ORLv2

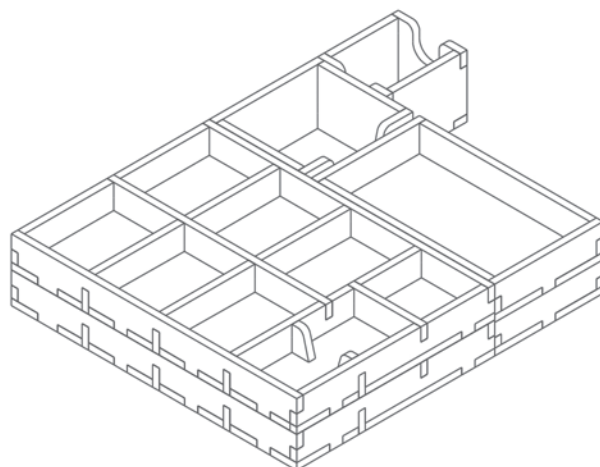

Sheet A1

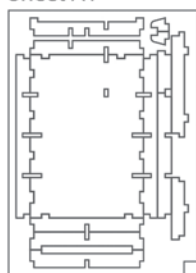

Sheet A2

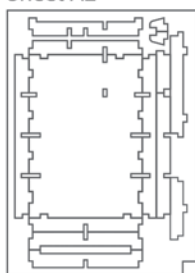

Sheet B1

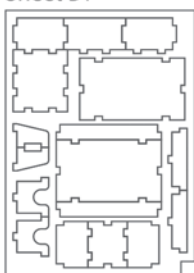

Tray 1a & 1b (the trays are identical)

Sheet A1

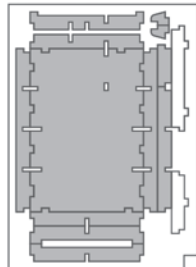

Sheet A2

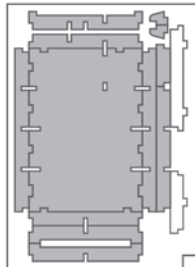

Step 1

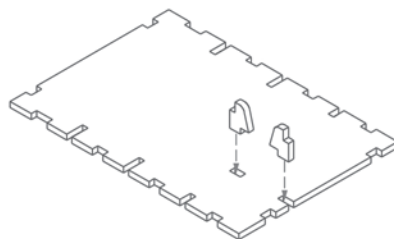

Step 2

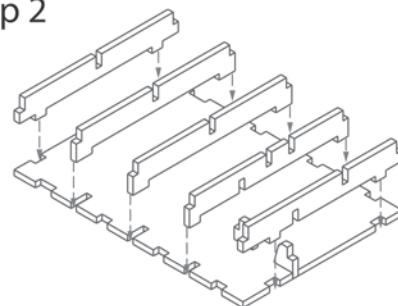

Step 3

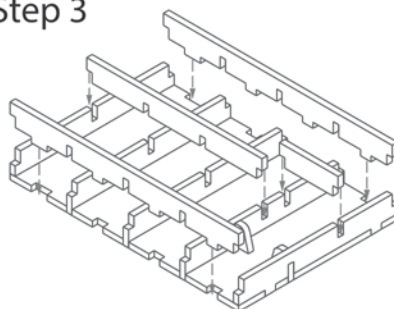

Finished tray

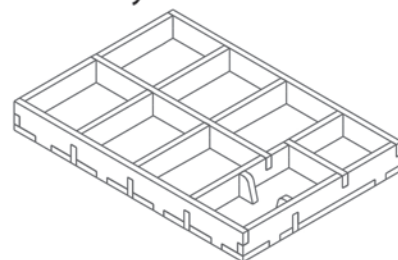

Tray 2

Sheet B1

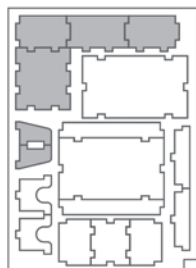

Step 1

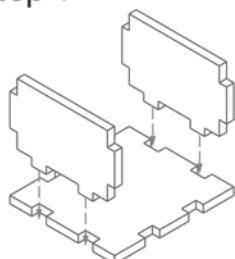

Step 2

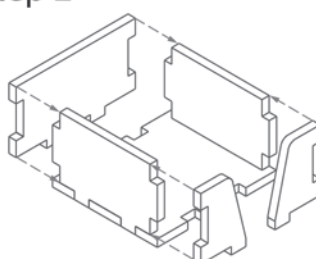

Finished tray

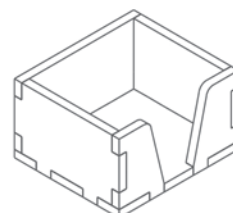

FS-ORLv2 insert compatible with Orleans[®],
both the DLP and TMG versions.

Tray 3a

Sheet A1, A2

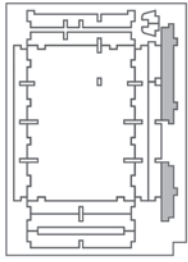

Sheet B1

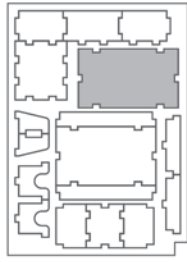

Step 1

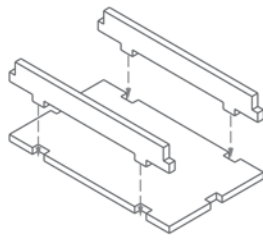

Step 2

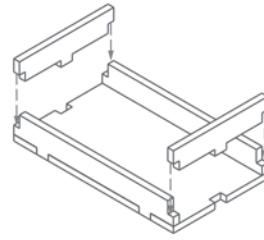

Finished tray

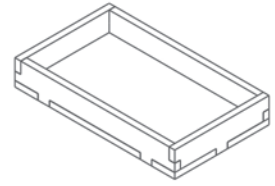

Tray 3b (the tray is taller than Tray 3a)

Sheet B1

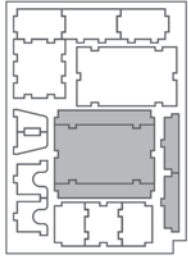

Step 1

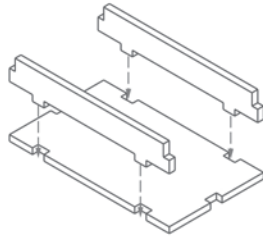

Step 2

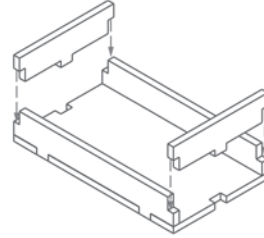

Finished tray

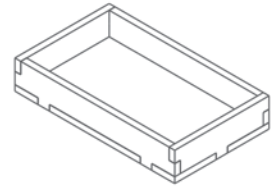

Tray 4

Sheet B1

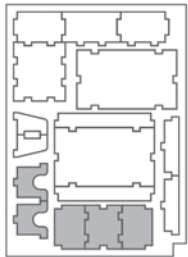

Step 1

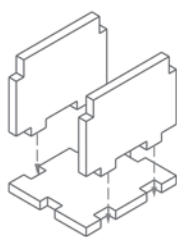

Step 2

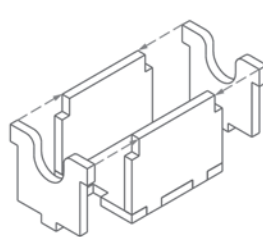

Finished tray

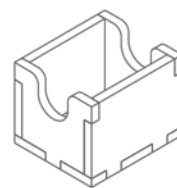

FS-ORLv2

Please check www.foldedspace.net for photos of this insert in use.

Tray legend:

- Tray 1a - player pieces, citizen tiles, start player token, & overview cards
- Tray 1b - character tiles & technology tiles
- Tray 2 - place tiles
- Tray 3a - coins
- Tray 3b - goods tiles
- Tray 4 - hour glass tiles

The cloth bags should be rolled up and placed in the space next to trays 3 and 4.

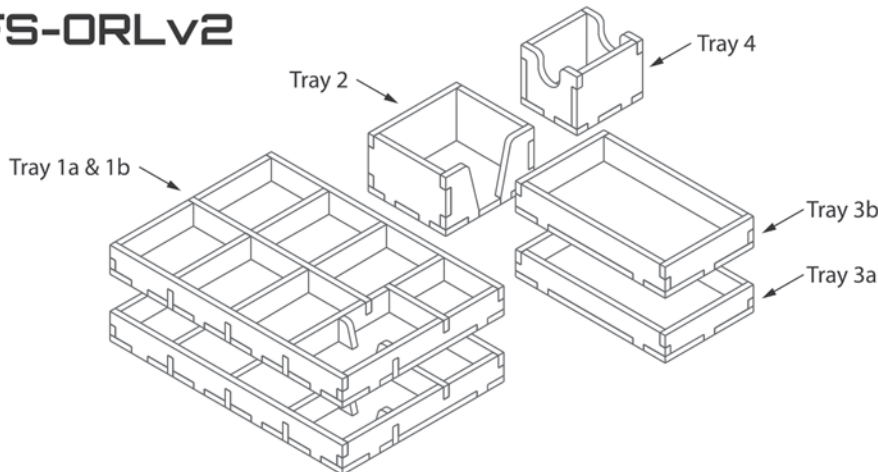

FS-ORLv2 also works with the TMG version of the game. The layout on the right shows how the trays should be arranged for this version. Note that as the box height is less for the TMG version there will be 5mm of lid rise when used in this way.

The cloth bags should be rolled up and placed in the space next to trays 1 and 4.

TMG version

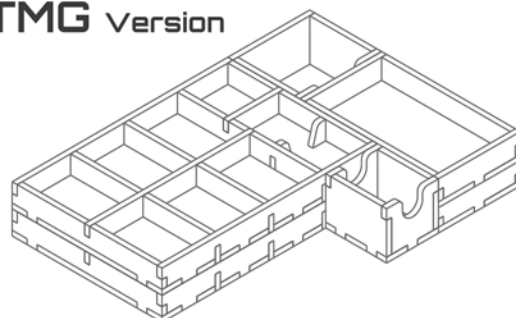

Tip: Keep the instructions in the bottom of your board game box as a reminder of how the insert fits together.